

ALÇADO L. DIREITO

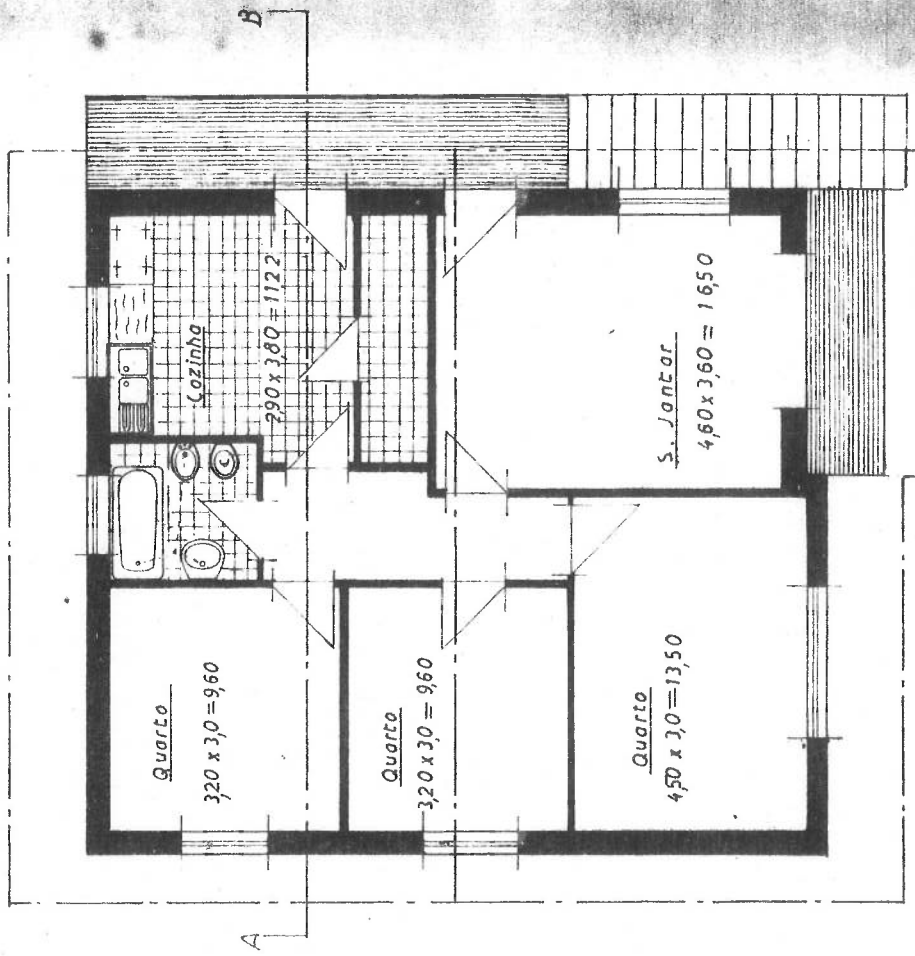

PLANTA DO ANDAR E COBERTURA

ES

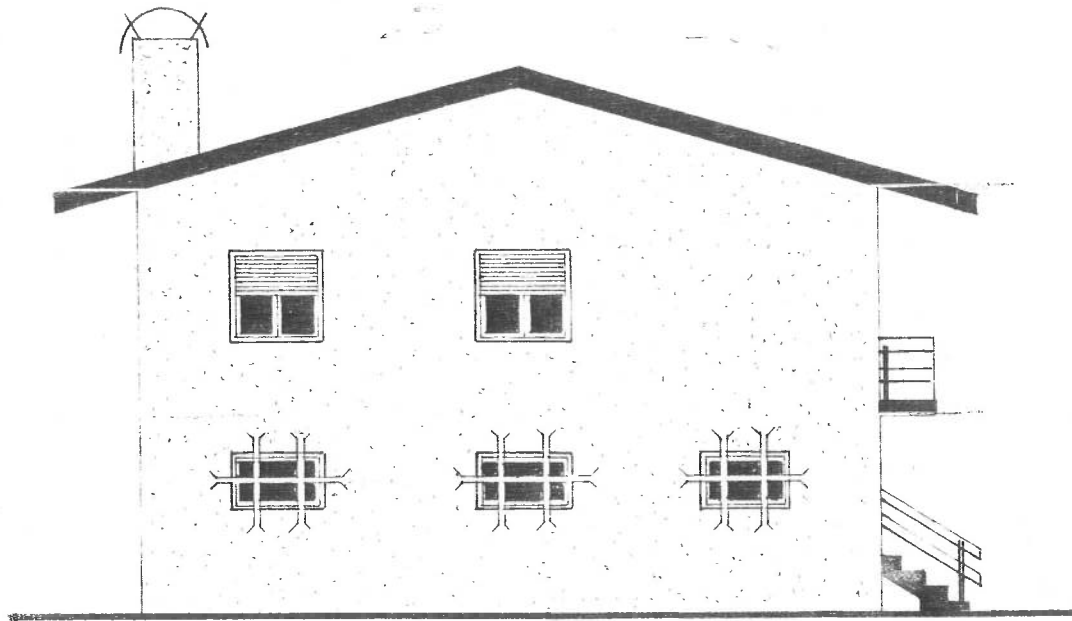

ALÇADO L ESQUERDO

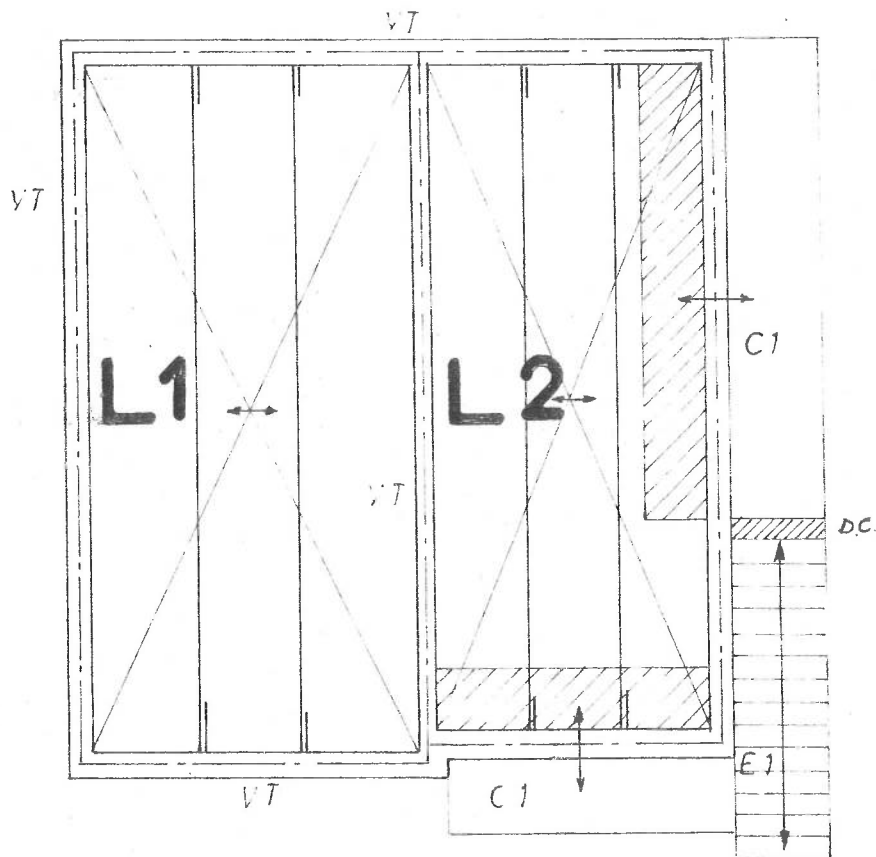

V1  
H

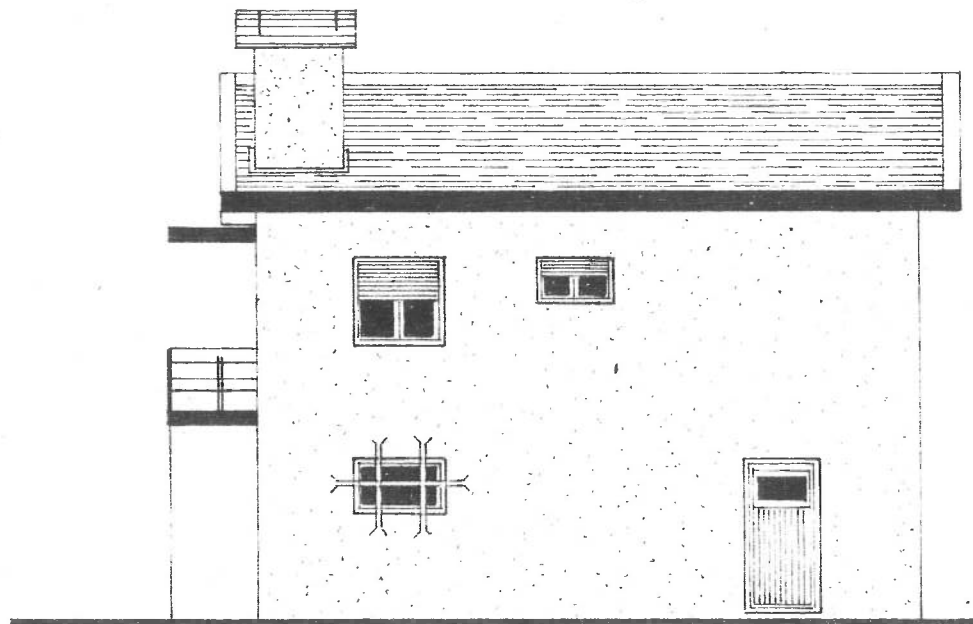

ALÇADO POSTERIOR

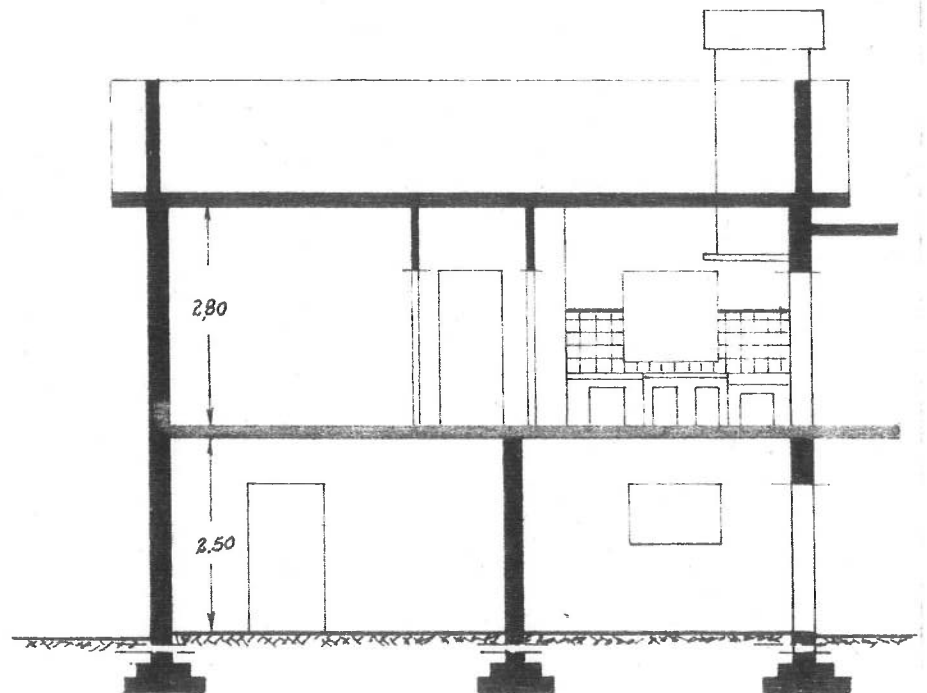

CORTE - A-B

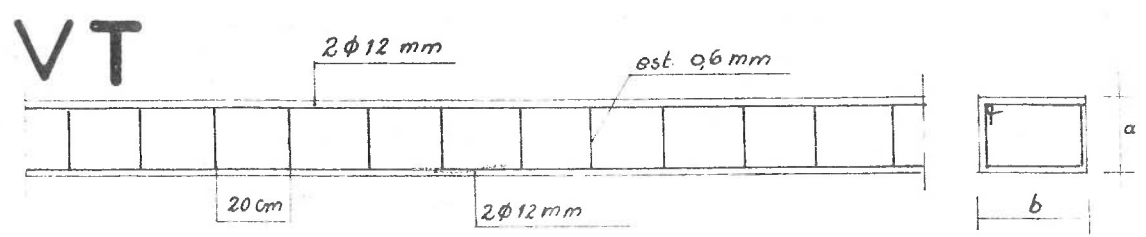
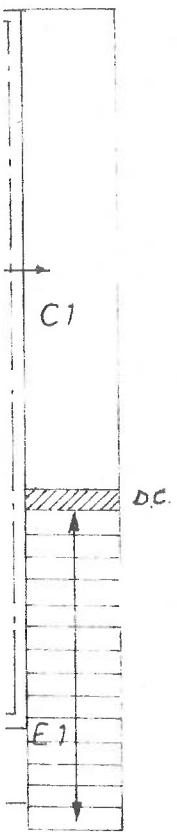
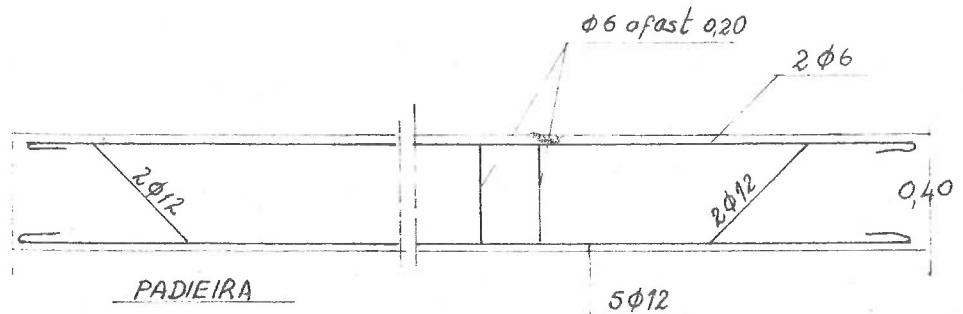
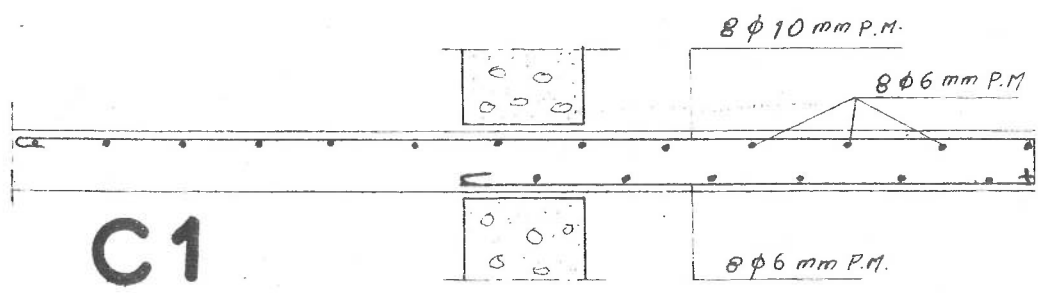
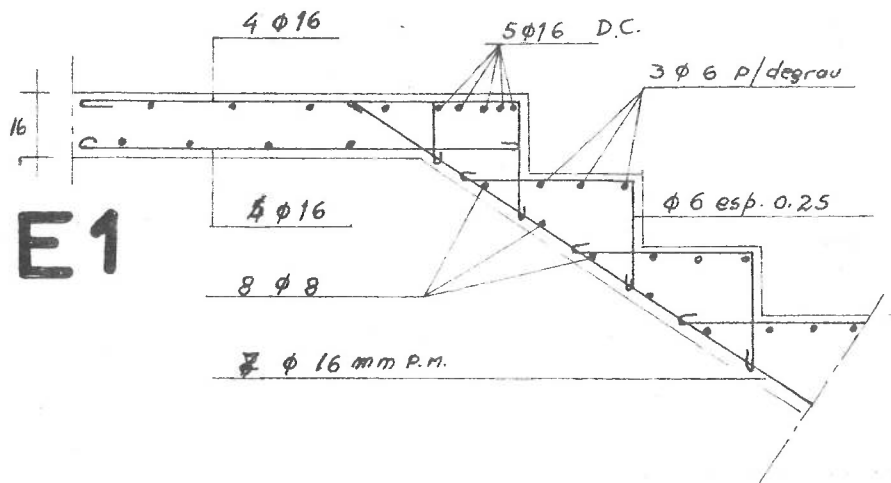
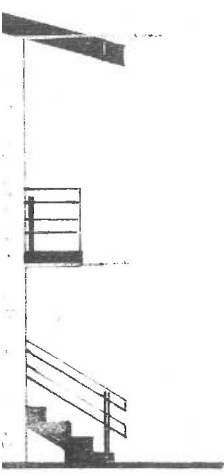

a - espessura da Lage

b " da parede

PLACA MARCA PARIAL

Referencia	Tipo	M	I	ARM
L1	3a-4 $\phi 4$ +3 $\phi 3,2$	2160	1860	Melhoresl
L2	2a-bdL	1670	1860	"

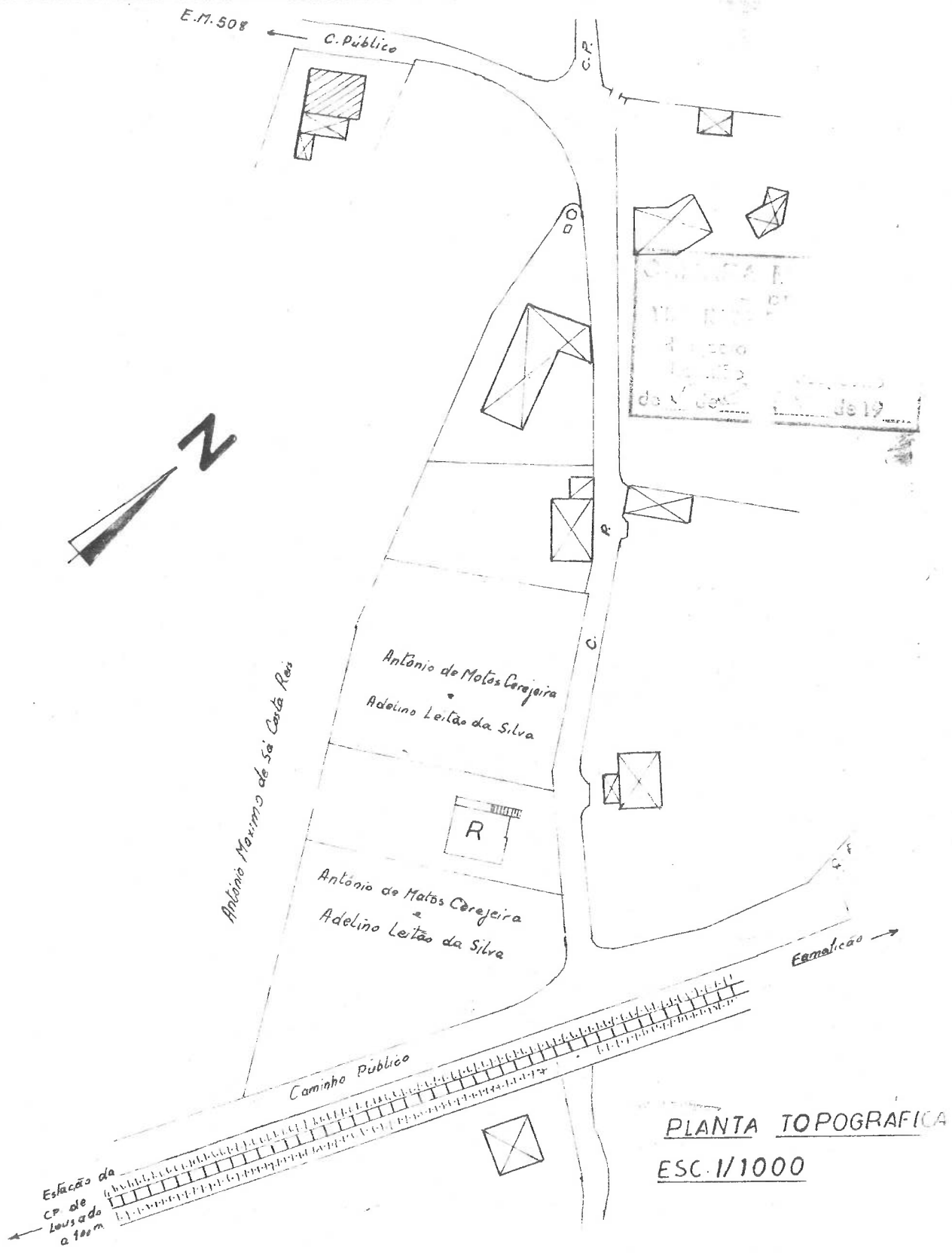

13

PLANTA TOPOGRAFICA  
ESC. 1/1000

Requerente	ANTÓNIO VIEIRA LOURENÇO
Lugar	GANDRA - LOUSADO
Concelho	V. N. FAMALICÃO
Escalas 1/20 1/100 1/1000	PROJECTO DE UMA MORADIA Plantas Alçados, Corte e Planta Topográfica